



Reinbold
Entsorgungstechnik



„BEAR“ FORCE AND RELIABILITY

HORIZONTAL SHREDDER

**RLZ -
RHZ and RHZ plus**



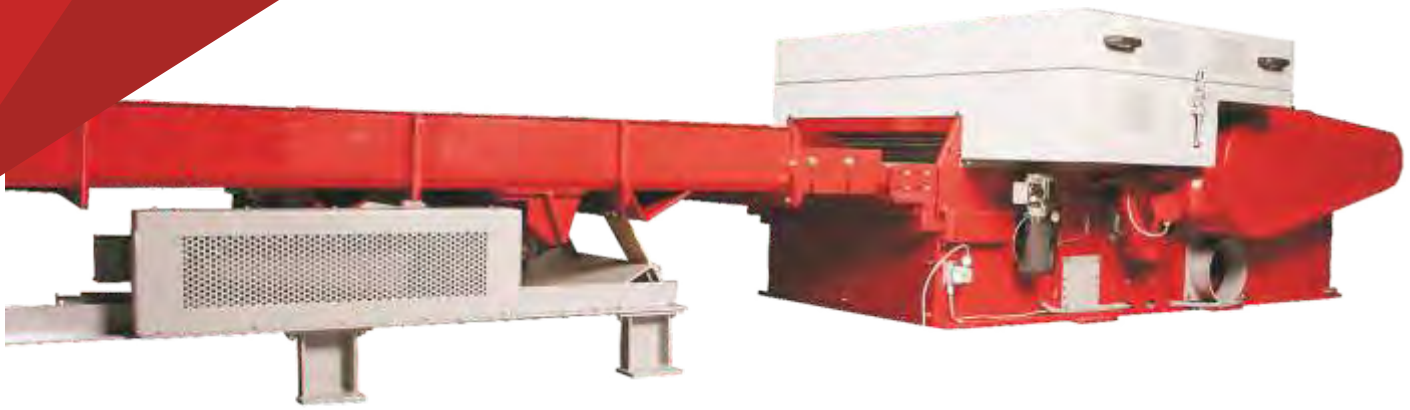

Shredders with link chain feed, the RHZ 400 plus S - RHZ 1300 plus S series



RHZ plus series horizontal shredders are used to shred long and short wood waste, chip board, packages and strips. The materials can also be fed to the rotor in packages using the special link chain feed.

The material to be shredded is entered and fed to the rotor via a vibration chamfer that is as wide as the horizontal shredder.

The material stack is caught by the chain belts, pressed together and supplied to the rotor.

The feed is controlled based on load.

A rotor construction with a diameter of 500 mm is available for more throughput.

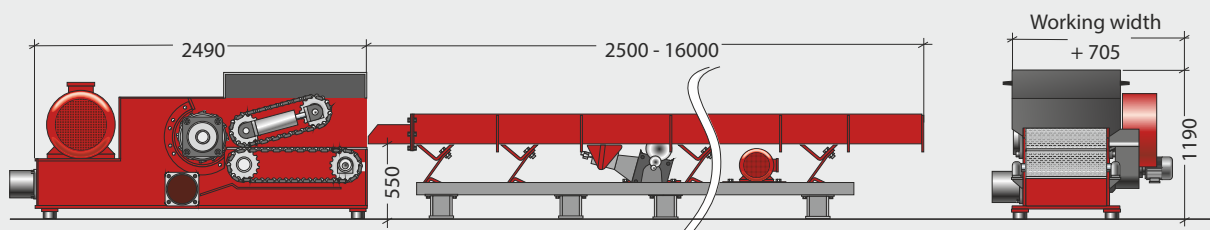
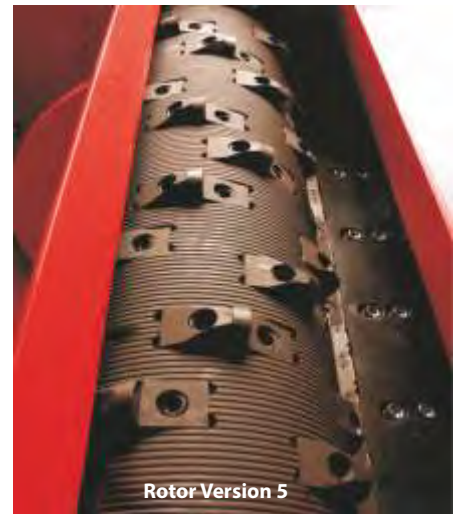

Type		RHZ 400 plus S	RHZ 600 plus S	RHZ 800 plus S	RHZ 1000 plus S	RHZ 1300 plus S
Feed opening	(mm)	400	600	800	1000	1300
Throughput	(approx. kg/h)*	1,800	2,300	3,000	3,500	4,000
Rotor diameter	(mm)**	354	354/500	354/500	354/500	354/500
Power required	(kW)	22/30/37/45	37/45/55	45/55/75	45/55/90/110	55/75/90/110
Tools	(Pcs.)	20	30	40/60	50/75	64/96
Screen perforation	(mm)	20 - 100	20 - 100	20 - 100	20 - 100	20 - 100
Suction piece Ø	(mm)	250/300	250/300	250/300	250/300	250/300
Weight	(approx. kg)	1,800	2,400	3,000	4,000	5,000

* screen 35 mm / depending on the type of material · ** Rotor diameter 500 mm = RHZ Gigant plus series



Compact construction, the RHZ 300 - RHZ 1300 S series

The Reinbold RHZ series is equipped with smart details: Two feed rolls and special strips ensure better material feed and simpler loading of the machine. The optional second feed roll ensures optimal material intake and thus a constant high throughput. The feed unit is controlled based on load and shuts off automatically if there is too much material. Thus the rotor can continue shredding without malfunctioning and is not overloaded. Thus, a maximum throughput guarantees with low power consumption.

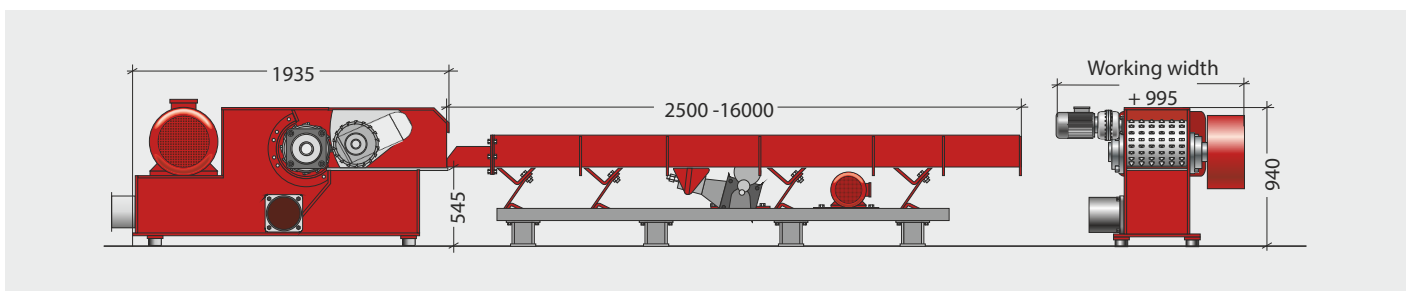

Type		RHZ 300	RHZ 400 / 400 S	RHZ 600 / 600 S	RHZ 800 S	RHZ 1000 S	RHZ 1300 S
Feed opening	(mm)	300	400	600	800	1,000	1,300
Throughput	(approx. kg/h)	depending on the type of material and screen used					
Rotor diameter	(mm)*	252	252/354	252/354	354/500	354/500	354/500
Power required	(kW)	18,5/22	18,5/22/30/37	22/30/37/45	37/45/55/75/90	37/45/55/75/90	45/55/75
Tools	(Pcs.)	8	10/20	15/30	40/60	50/75	64/96
Screen perforation	(mm)	20 - 100	20 - 100	20 - 100	20 - 100	20 - 100	20 - 100
Suction piece Ø	(mm)	250	250/300	250/300	250/300	250/300	250/300
Weight	(approx. kg)	900	1,000/1,400	1,900	2,300/3,200	2,800/3,200	3,300/4,500

* Rotor diameter 500mm = RHZ Gigant series



Strip shredders with angled feeds, the RLZ 400 - RLZ 800 series

The small strip shredders with angled feeds in the RLZ series for disposal of long thin wood waste such as strips and slats are implemented right beside the machining equipment.

The material to be shredded is entered directly in the rotor width of the RLZ. The material is supplied directly to the rotor using a feed roll.

The feed works based on load and shuts off automatically. This is carried out until the material is fully shredded.

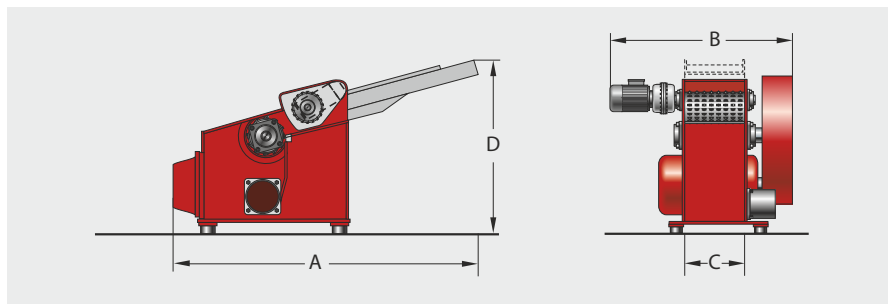

Type		RLZ 400	RLZ 600	RLZ 800
Feed opening	(mm)	400 x 50	600 x 50	800 x 50
Throughput	(approx. kg/h)	depending on the type of material and screen used		
Rotor diameter	(mm)	252	252	252
Rotor speed	(rpm)	200 - 300	200 - 300	200 - 300
Power required	(kW)	15/18,5	22	30
Tools	(Pcs.)	10	15	20
Screen perforation	(mm)	20-50	20-50	20-50
Suction piece Ø	(mm)	200	200	200
Air	(m/sec)	28	28	28
Weight	(approx. kg)	1,000	1,300	1,700
Size A	(mm)	2,190	2,190	2,190
Size B	(mm)	965	1,200	1,420
Size C	(mm)	400	600	800
Size D	(mm)	1,100	1,100	1,100
Size E	(mm)	685	685	685

More sizes and models are available!

Detailed dimensions upon request. (All dimensions in mm).



Reinbold material shredders: application images



With special chain feed



RHZ 400 S set up below ground



RHZ 400 S is ready for delivery



RHZ 1300 Plus Spezial



RHZ 1300 Gigant Plus



RHZ 1000 plus in use

The circular knife system: Cutting knives that lower your operating costs!

* New at Reinbold:

The outer broaching knife, are replaced by the circular knife V8. This promotes a uniform crushing of materials over the entire length of the rotor.

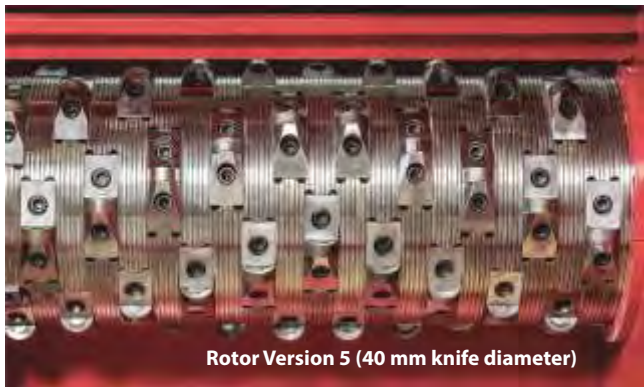

Rotor Version 5 (40 mm knife diameter)

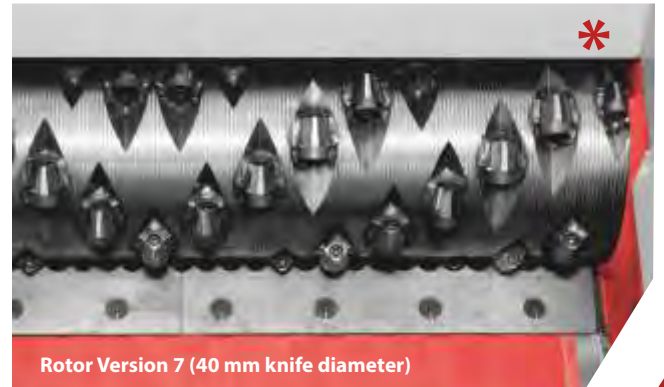

Rotor Version 7 (40 mm knife diameter)



Rotor Version 8 (30 mm knife diameter)

The highly efficient scissors cut of the concave ground circular cutting heads provide a very high work rate with very little effort. The knife holders are welded or mounted on the rotor and the round knives can be turned up to **8 times** with just a few adjustments before having to be exchanged completely. The use of various types of knives enables job-related adjustment of the shredder to the material being processed.



The knives with horizontally integrated square knives are especially suitable for manufacturing granulate which can be used in cellulose production.



Machines from the Reinbold product line:



Series AZR 600:
The universal single shaft shredder for
woodworking shops



Series AZR 800 - AZR 2000 Gigant S:
The single shaft shredder for professional
compaction of recyclables



Series RMZ 500 - RMZ 1000 S:
The four-shaft shredder that is ideal
for shredding long stock



Series RB 20 SV - RB 50 SV:
The small but powerful briquetting press



Series RB 100 - RB 300 Flexible S:
For briquetting chips and dust



Series RB 400 RS - RB 600 RS:
For the industrial production of
square briquettes

Drawing on its many years of experience, Reinbold, with its broad range of machines, is able to offer ideal solutions for different applications in material shredding and briquetting.

Our testing facility is available to perform tests on your material.

Reinbold Entsorgungstechnik GmbH

Robert-Mayer-Strasse 5
74360 Ilsfeld (Germany)

Phone: +49 (0) 7062 / 97885-0

Fax: +49 (0) 7062 / 97885-50

info@reinbold.de

www.reinbold.de

Your dealer:

